

# REFRIGERAÇÃO - TUDO DISTRIBUIDOR

MODELO TUBO/TUBO DUPLO - CONEXÃO RÁPIDA - TUBO DISTRIBUIDOR



MODELO: TUBO SIMPLES

ABRAÇADEIRA MOD KV  
(PARA TUBO SIMPLES)

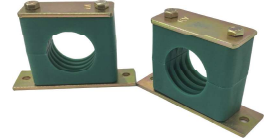

VIA PRINCIPAL



Termômetro Manômetro

VIAS SECUNDÁRIAS

## MODELO: TUBO DUPLO

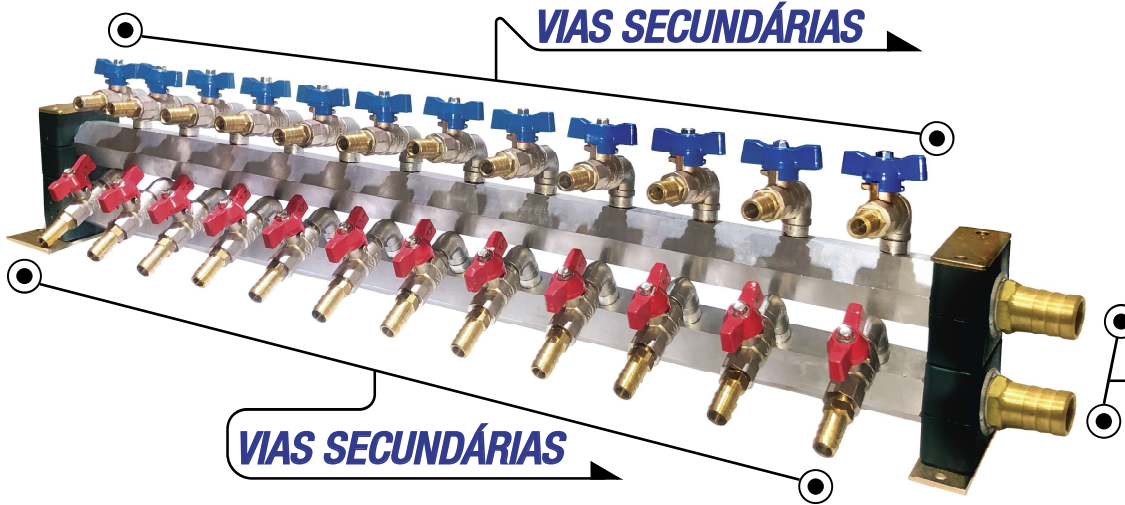

ABRAÇADEIRA MOD KV2  
(PARA TUBO DUPLO)



VIA PRINCIPAL

VIAS SECUNDÁRIAS

VIAS SECUNDÁRIAS

Tubo simples:  
De 02 a 20 vias

Tubo Duplo:  
De 04 a 40 vias

Fabricamos  
projetos especiais

### COMO PEDIR MANIFOLD (TB):

- 01 - Definir se é tubo SIMPLES ou DUPLO;
- 02 - Definir Quantidade de VIAS SECUNDÁRIAS (4,6,8,10, 12,14,16,18,20) por tubo ;
- 03 - Definir Espigão da VIA PRINCIPAL (3/4" OU 1");
- 04 - Definir Modelo das VIAS SECUNDÁRIAS:  
(ESPIGAO 3/8" OU 1/2")  
(CONEXÃO PC0802 OU PC1002 OU PC1202)  
(ROSCA 1/4 NPT)  
(PLUG NP31 PARA CONECTOR MODELO C014 OU C013)

| VIAS SECUNDÁRIA (QUANTIDADE) | VIA PRINCIPAL | MODELO DE VIA SECUNDÁRIA |
|------------------------------|---------------|--------------------------|
| 4                            | OU<br>3/4" 1" | ESPIGAO MANGUEIRA 3/8    |
| 6                            |               | ESPIGAO MANGUEIRA 1/2    |
| 8                            |               | CONEXÃO RÁPIDA PC0802    |
| 10                           |               | CONEXÃO RÁPIDA PC1002    |
| 12                           |               | CONEXÃO RÁPIDA PC1202    |
| 14                           |               | ROSCA 1/4 NPT            |
| 16                           |               | PLUG NP 31 PARA CONECTOR |
| 18                           |               | MODELO C014 OU C013      |
| 20                           |               | (ENGATE RÁPIDO LATÃO)    |



Espigão 3/8" / 1"  
Ver Pag. 41



Conexão PC0802/  
1002/1202  
Ver Pag. 42



PLUG NP31  
Ver Pag. 39

### VIAS SECUNDÁRIAS

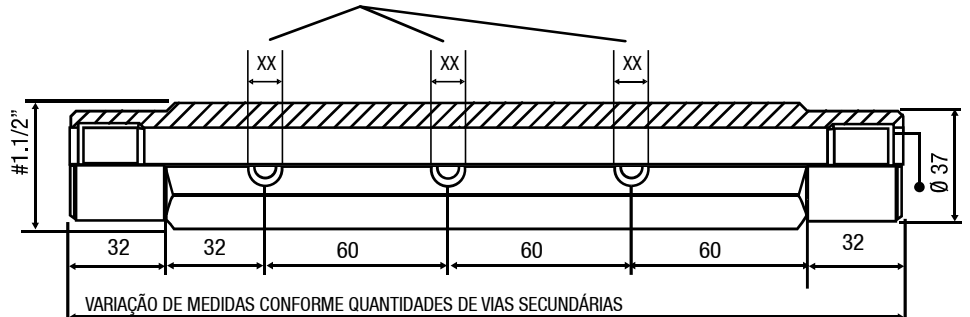

# REFRIGERAÇÃO - ENGATES RÁPIDOS EM LATÃO PARA LÍQUIDOS

## Modelo CO - CONECTOR

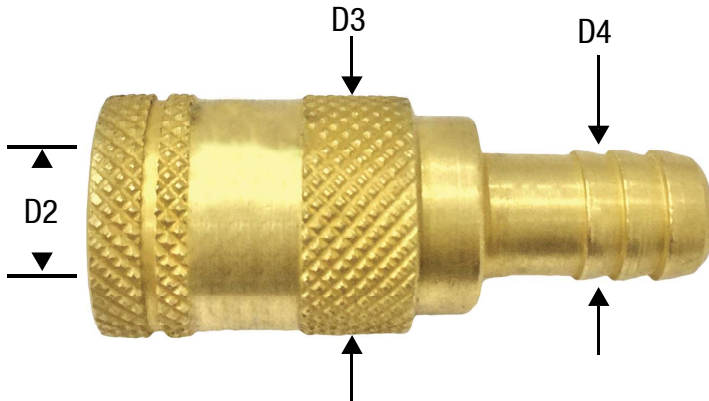

| Utiliza plugs nº NP/BS | Furo Interno D2-mm | Medida Externa D3-mm | Para Mangueira D4-mm | Código |
|------------------------|--------------------|----------------------|----------------------|--------|
| 20-21-22               | 9,5                | 18,0                 | 1/4                  | C011   |
| 20-21-22               | 9,5                | 18,0                 | 3/8                  | C012   |
| 30-31-32-33            | 13,5               | 24,5                 | 3/8                  | C013   |
| 30-31-32-33            | 13,5               | 24,5                 | 1/2                  | C014   |
| 34-35                  | 20,0               | 30,5                 | 3/4                  | C015   |
| 34-35                  | 20,0               | 30,5                 | 1"                   | C016   |

## Modelo NP/BS - PLUG

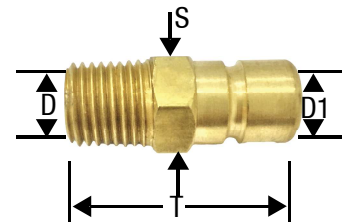

| Rosca gás NPT/BSP | Chave Sextavada S | Furo Interno D | Encaixe no conector D1 | Compr. Total T | Código |
|-------------------|-------------------|----------------|------------------------|----------------|--------|
| 1/8 NPT           | 7/16              | 5              | 9,2                    | 24             | NP20   |
| 1/8 BSP           | 7/16              | 5              | 9,2                    | 24             | BS20   |
| 1/4 NPT           | 9/16              | 6              | 9,2                    | 29             | NP21   |
| 1/4 BSP           | 9/16              | 6              | 9,2                    | 29             | BS21   |
| 3/8 NPT           | 11/16             | 8              | 9,2                    | 31             | NP22   |
| 3/8 BSP           | 11/16             | 8              | 9,2                    | 31             | BS22   |
| 1/8 NPT           | 9/16              | 5              | 13,1                   | 31             | NP30   |
| 1/8 BSP           | 9/16              | 5              | 13,1                   | 31             | BS30   |
| 1/4 NPT           | 9/16              | 9              | 13,1                   | 35             | NP31   |
| 1/4 BSP           | 9/16              | 9              | 13,1                   | 35             | BS31   |
| 3/8 NPT           | 11/16             | 9              | 13,1                   | 35             | NP32   |
| 3/8 BSP           | 11/16             | 9              | 13,1                   | 35             | BS32   |
| 1/2 NPT           | 7/8               | 9              | 13,1                   | 38             | NP33   |
| 1/2 BSP           | 7/8               | 9              | 13,1                   | 38             | BS33   |
| 3/4 NPT           | 1 1/8             | 14             | 19,5                   | 46             | NP34   |
| 3/4 BSP           | 1 1/8             | 14             | 19,5                   | 46             | BS34   |
| 1" NPT            | 1 5/16            | 14             | 19,5                   | 48             | NP35   |
| 1" BSP            | 1 5/16            | 14             | 19,5                   | 48             | BS35   |

## Modelo C045 - CONECTOR



| Utiliza plugs nº NP/BS | Furo Interno D2-mm | Medida Externa D3-mm | Para Mangueira D4-mm | Código  |
|------------------------|--------------------|----------------------|----------------------|---------|
| 20-21-22               | 9,5                | 18,0                 | 1/4                  | C01145° |
| 20-21-22               | 9,5                | 18,0                 | 3/8                  | C01245° |
| 30-31-32-33            | 13,5               | 24,5                 | 3/8                  | C01345° |
| 30-31-32-33            | 13,5               | 24,5                 | 1/2                  | C01445° |
| 34-35                  | 20,0               | 30,5                 | 3/4                  | C01545° |
| 34-35                  | 20,0               | 30,5                 | 1"                   | C01645° |

## Modelo NP/BS 45 - PLUG

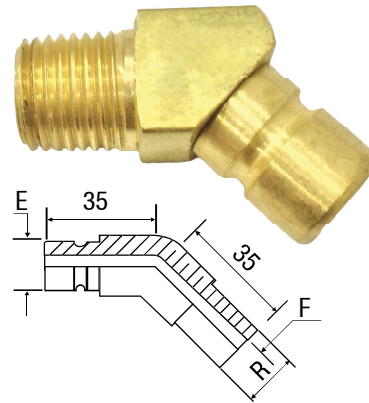

| Rosca Gaz NPT/BSP | Código   |
|-------------------|----------|
| 1/8" NPT          | NP20 45° |
| 1/8" BSP          | BS20 45° |
| 1/4" NPT          | NP21 45° |
| 1/4" BSP          | BS21 45° |
| 1/8" NPT          | NP30 45° |
| 1/8" BSP          | BS30 45° |
| 1/4" NPT          | NP31 45° |
| 1/4" BSP          | BS31 45° |
| 3/8" NPT          | NP32 45° |
| 3/8" BSP          | BS32 45° |

## Modelo C090 - CONECTOR

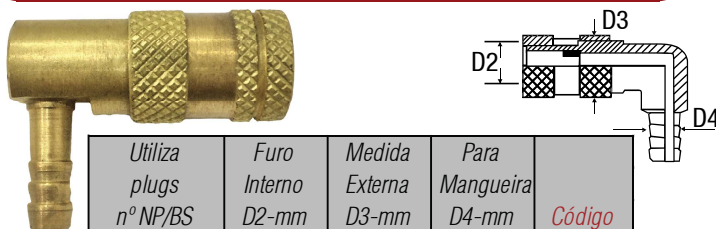

| Utiliza plugs nº NP/BS | Furo Interno D2-mm | Medida Externa D3-mm | Para Mangueira D4-mm | Código   |
|------------------------|--------------------|----------------------|----------------------|----------|
| 20-21-22               | 9,5                | 18,0                 | 1/4                  | C011 90° |
| 20-21-22               | 9,5                | 18,0                 | 3/8                  | C012 90° |
| 30-31-32-33            | 13,5               | 24,5                 | 3/8                  | C013 90° |
| 30-31-32-33            | 13,5               | 24,5                 | 1/2                  | C014 90° |
| 34-35                  | 20,0               | 30,5                 | 3/4                  | C015 90° |
| 34-35                  | 20,0               | 30,5                 | 1"                   | C016 90° |

## Modelo NP/BS 90 - PLUG

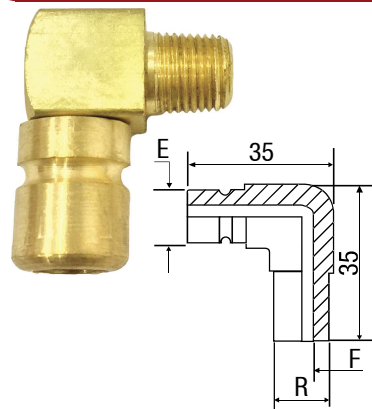

| Rosca Gaz NPT/BSP | Código   |
|-------------------|----------|
| 1/8" NPT          | NP20 90° |
| 1/8" BSP          | BS20 90° |
| 1/4" NPT          | NP21 90° |
| 1/4" BSP          | BS21 90° |
| 1/8" NPT          | NP30 90° |
| 1/8" BSP          | BS30 90° |
| 1/4" NPT          | NP31 90° |
| 1/4" BSP          | BS31 90° |
| 3/8" NPT          | NP32 90° |
| 3/8" BSP          | BS32 90° |

# REFRIGERAÇÃO - ENGATES RÁPIDOS EM LATÃO PARA LÍQUIDOS VALVULADOS

Modelo COV - CONECTOR VALVULADO

Modelo NPV/BSV - PLUG VALVULADO

**LINHA DE ENGATE VALVULADOS: RETÉM O LÍQUIDO, NÃO PRECISA DESLIGAR O REGISTRO APÓS SER DESCONECTADO.**

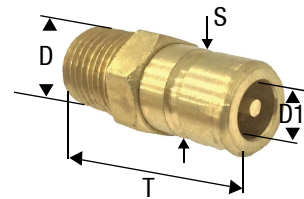
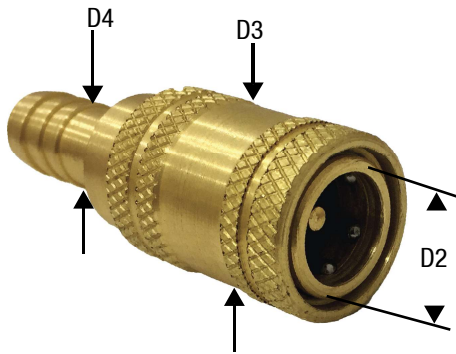

| Utiliza plugs n° NPV/BSV | Furo Interno D2-mm | Medida Externa D3-mm | Para Mangueira D4-mm | Código |
|--------------------------|--------------------|----------------------|----------------------|--------|
| 20-21-22                 | 9,5                | 18,0                 | 1/4                  | COV11  |
| 20-21-22                 | 9,5                | 18,0                 | 3/8                  | COV12  |
| 30-31-32-33              | 13,5               | 24,5                 | 3/8                  | COV13  |
| 30-31-32-33              | 13,5               | 24,5                 | 1/2                  | COV14  |
| 34-35                    | 20,0               | 30,5                 | 3/4                  | COV15  |
| 34-35                    | 20,0               | 30,5                 | 1"                   | COV16  |

| Rosca gás NPTV/BSPV | Chave Sextavada S | Furo Interno D | Encaixe no Conector D1 | Compr. Total T | Código |
|---------------------|-------------------|----------------|------------------------|----------------|--------|
| 1/8 NPTV            | 7/16              | 5              | 9,2                    | 24             | NPV20  |
| 1/8 BSPV            | 7/16              | 5              | 9,2                    | 24             | BSV20  |
| 1/4 NPTV            | 9/16              | 6              | 9,2                    | 29             | NPV21  |
| 1/4 BSPV            | 9/16              | 6              | 9,2                    | 29             | BSV21  |
| 3/8 NPTV            | 11/16             | 8              | 9,2                    | 31             | NPV22  |
| 3/8 BSPV            | 11/16             | 8              | 9,2                    | 31             | BSV22  |
| 1/8 NPTV            | 9/16              | 5              | 13,1                   | 31             | NPV30  |
| 1/8 BSPV            | 9/16              | 5              | 13,1                   | 31             | BSV30  |
| 1/4 NPTV            | 9/16              | 9              | 13,1                   | 35             | NPV31  |
| 1/4 BSPV            | 9/16              | 9              | 13,1                   | 35             | BSV31  |
| 3/8 NPTV            | 11/16             | 9              | 13,1                   | 35             | NPV32  |
| 3/8 BSPV            | 11/16             | 9              | 13,1                   | 35             | BSV32  |
| 1/2 NPTV            | 7/8               | 9              | 13,1                   | 38             | NPV33  |
| 1/2 BSPV            | 7/8               | 9              | 13,1                   | 38             | BSV33  |
| 3/4 NPTV            | 1 1/8             | 14             | 19,5                   | 46             | NPV34  |
| 3/4 BSPV            | 1 1/8             | 14             | 19,5                   | 46             | BSV34  |
| 1" NPTV             | 1 5/16            | 14             | 19,5                   | 48             | NPV35  |
| 1" BSPV             | 1 5/16            | 14             | 19,5                   | 48             | BSV35  |

## Modelo COV 45 - CONECTOR VALVULADO

## Modelo NPV/BSV 45 - PLUG VALVULADO

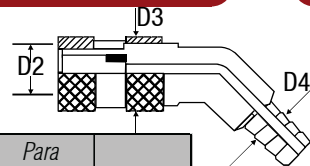
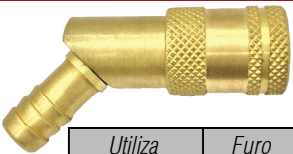

| Utiliza plugs n° NPV/BSV | Furo Interno D2-mm | Medida Externa D3-mm | Para Mangueira D4-mm | Código   |
|--------------------------|--------------------|----------------------|----------------------|----------|
| 20-21-22                 | 9,5                | 18,0                 | 1/4                  | COV1145° |
| 20-21-22                 | 9,5                | 18,0                 | 3/8                  | COV1245° |
| 30-31-32-33              | 13,5               | 24,5                 | 3/8                  | COV1345° |
| 30-31-32-33              | 13,5               | 24,5                 | 1/2                  | COV1445° |
| 34-35                    | 20,0               | 30,5                 | 3/4                  | COV1545° |
| 34-35                    | 20,0               | 30,5                 | 1"                   | COV1645° |

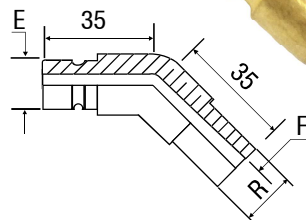
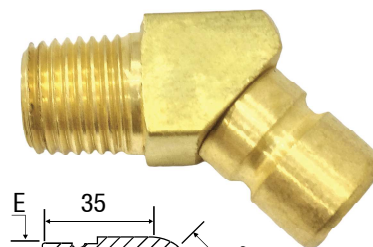

| Rosca Gaz NPVT/BSV | Código    |
|--------------------|-----------|
| 1/8" NPTV          | NPV20 45° |
| 1/8" BSPV          | BSV20 45° |
| 1/4" NPTV          | NPV21 45° |
| 1/4" BSPV          | BSV21 45° |
| 1/8" NPTV          | NPV30 45° |
| 1/8" BSPV          | BSV30 45° |
| 1/4" NPTV          | NPV31 45° |
| 1/4" BSPV          | BSV31 45° |
| 3/8" NPTV          | NPV32 45° |
| 3/8" BSPV          | BSV32 45° |

## Modelo COV 90 - CONECTOR VALVULADO

## Modelo NPV/BSV 90 - PLUG VALVULADO

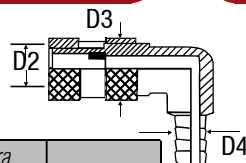
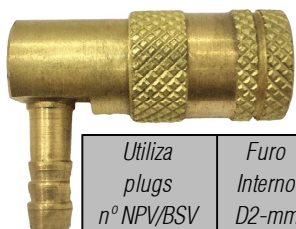

| Utiliza plugs n° NPV/BSV | Furo Interno D2-mm | Medida Externa D3-mm | Para Mangueira D4-mm | Código    |
|--------------------------|--------------------|----------------------|----------------------|-----------|
| 20-21-22                 | 9,5                | 18,0                 | 1/4                  | COV11 90° |
| 20-21-22                 | 9,5                | 18,0                 | 3/8                  | COV12 90° |
| 30-31-32-33              | 13,5               | 24,5                 | 3/8                  | COV13 90° |
| 30-31-32-33              | 13,5               | 24,5                 | 1/2                  | COV14 90° |
| 34-35                    | 20,0               | 30,5                 | 3/4                  | COV15 90° |
| 34-35                    | 20,0               | 30,5                 | 1"                   | COV16 90° |

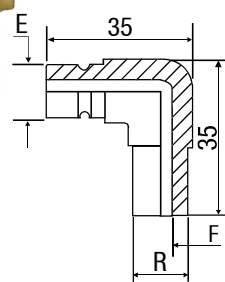
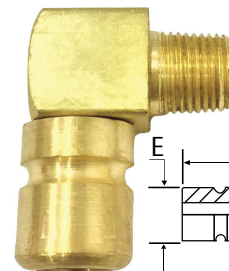

| Rosca Gaz NPVT/BSV | Código    |
|--------------------|-----------|
| 1/8" NPTV          | NPV20 90° |
| 1/8" BSPV          | BSV20 90° |
| 1/4" NPTV          | NPV21 90° |
| 1/4" BSPV          | BSV21 90° |
| 1/8" NPTV          | NPV30 90° |
| 1/8" BSPV          | BSV30 90° |
| 1/4" NPTV          | NPV31 90° |
| 1/4" BSPV          | BSV31 90° |
| 3/8" NPTV          | NPV32 90° |
| 3/8" BSPV          | BSV32 90° |

# REFRIGERAÇÃO - PROLONGADOR, ESPIÇÃO E ABRAÇADEIRAS

Modelo PHA - PLUG com Haste Alongadora

PROLONGADOR

| Medida da letra mm | Rosca gás para molde NPT/BSP r | Furo interno F mm | Código     |
|--------------------|--------------------------------|-------------------|------------|
| A= 50              | 1/8 NPT                        | 5                 | PHA050NP30 |
|                    | 1/8 BSP                        | 5                 | PHA050BS30 |
|                    | 1/4 NPT                        | 8                 | PHA050NP31 |
|                    | 1/4 BSP                        | 8                 | PHA050BS31 |
| B = 75             | 1/8 NPT                        | 5                 | PHA075NP30 |
|                    | 1/8 BSP                        | 5                 | PHA075BS30 |
|                    | 1/4 NPT                        | 8                 | PHA075NP31 |
|                    | 1/4 BSP                        | 8                 | PHA075BS31 |
| C = 100            | 1/8 NPT                        | 5                 | PHA100NP30 |
|                    | 1/8 BSP                        | 5                 | PHA100BS30 |
|                    | 1/4 NPT                        | 8                 | PHA100NP31 |
|                    | 1/4 BSP                        | 8                 | PHA100BS31 |
| D= 125             | 1/8 NPT                        | 5                 | PHA125NP30 |
|                    | 1/8 BSP                        | 5                 | PHA125BS30 |
|                    | 1/4 NPT                        | 8                 | PHA125NP31 |
|                    | 1/4 BSP                        | 8                 | PHA125BS31 |
| E = 150            | 1/8 NPT                        | 5                 | PHA150NP30 |
|                    | 1/8 BSP                        | 5                 | PHA150BS30 |
|                    | 1/4 NPT                        | 8                 | PHA150NP31 |
|                    | 1/4 BSP                        | 8                 | PHA150BS31 |
| F = 200            | 1/8 NPT                        | 5                 | PHA200NP30 |
|                    | 1/8 BSP                        | 5                 | PHA200BS30 |
|                    | 1/4 NPT                        | 8                 | PHA200NP31 |
|                    | 1/4 BSP                        | 8                 | PHA200BS31 |

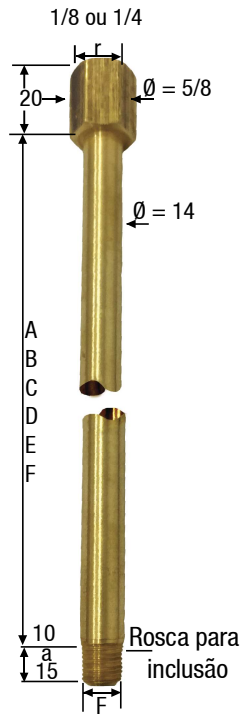

Medidas Especiais SOB ENCOMENDA

Plug Np31 com rosca 1/4" NF  
50mm comprimento haste

Medidas Especiais SOB ENCOMENDA

| Medida da letra mm | Rosca gás para molde NPT/BSP r | Furo interno F mm | Código |
|--------------------|--------------------------------|-------------------|--------|
| A = 50             | 1/8 NPT                        | 5                 | PAN-1  |
|                    | 1/8 BSP                        | 5                 | PAB-1  |
|                    | 1/4 NPT                        | 8                 | PAN-2  |
|                    | 1/4 BSP                        | 8                 | PAB-2  |
| B = 70             | 1/8 NPT                        | 5                 | PBN-1  |
|                    | 1/8 BSP                        | 5                 | PBB-1  |
|                    | 1/4 NPT                        | 8                 | PBN-2  |
|                    | 1/4 BSP                        | 8                 | PBB-2  |
| C = 90             | 1/8 NPT                        | 5                 | PCN-1  |
|                    | 1/8 BSP                        | 5                 | PCB-1  |
|                    | 1/4 NPT                        | 8                 | PCN-2  |
|                    | 1/4 BSP                        | 8                 | PCB-2  |
| D = 105            | 1/8 NPT                        | 5                 | PDN-1  |
|                    | 1/8 BSP                        | 5                 | PDB-1  |
|                    | 1/4 NPT                        | 8                 | PDN-2  |
|                    | 1/4 BSP                        | 8                 | PDB-2  |
| E = 120            | 1/8 NPT                        | 5                 | PEN-1  |
|                    | 1/8 BSP                        | 5                 | PEB-1  |
|                    | 1/4 NPT                        | 8                 | PEN-2  |
|                    | 1/4 BSP                        | 8                 | PEB-2  |
| F = 150            | 1/8 NPT                        | 5                 | PFN-1  |
|                    | 1/8 BSP                        | 5                 | PFB-1  |
|                    | 1/4 NPT                        | 8                 | PFN-2  |
|                    | 1/4 BSP                        | 8                 | PFB-2  |
| G = 200            | 1/8 NPT                        | 5                 | PGN-1  |
|                    | 1/8 BSP                        | 5                 | PGB-1  |
|                    | 1/4 NPT                        | 8                 | PGN-2  |
|                    | 1/4 BSP                        | 8                 | PGB-2  |
| H = 250            | 1/8 NPT                        | 5                 | PHN-1  |
|                    | 1/8 BSP                        | 5                 | PHB-1  |
|                    | 1/4 NPT                        | 8                 | PHN-2  |
|                    | 1/4 BSP                        | 8                 | PHB-2  |
| I = 300            | 1/8 NPT                        | 5                 | PIN-1  |
|                    | 1/8 BSP                        | 5                 | PIB-1  |
|                    | 1/4 NPT                        | 8                 | PIN-2  |
|                    | 1/4 BSP                        | 8                 | PIB-2  |

## Modelo ER - ESPIÇÃO com Rosca

| Rosca | Mangureira | Código      |
|-------|------------|-------------|
| 1/8   | 1/4        | ER1/8NP1/4M |
| 1/8   | 1/4        | ER1/8BS1/4M |
| 1/8   | 3/8        | ER1/8NP3/8M |
| 1/8   | 3/8        | ER1/8BS3/8M |
| 1/8   | 1/2        | ER1/8NP1/2M |
| 1/8   | 1/2        | ER1/8BS1/2M |
| 1/4   | 1/4        | ER1/4NP1/4M |
| 1/4   | 1/4        | ER1/4BS1/4M |
| 1/4   | 3/8        | ER1/4NP3/8M |
| 1/4   | 3/8        | ER1/4BS3/8M |
| 1/4   | 1/2        | ER1/4NP1/2M |
| 1/4   | 1/2        | ER1/4BS1/2M |
| 3/8   | 1/4        | ER3/8NP1/4M |
| 3/8   | 1/4        | ER3/8BS1/4M |
| 3/8   | 3/8        | ER3/8NP3/8M |
| 3/8   | 3/8        | ER3/8BS3/8M |
| 3/8   | 1/2        | ER3/8NP1/2M |
| 3/8   | 1/2        | ER3/8BS1/2M |
| 1/2   | 1/4        | ER1/2NP1/4M |
| 1/2   | 1/4        | ER1/2BS1/4M |
| 1/2   | 3/8        | ER1/2NP3/8M |
| 1/2   | 3/8        | ER1/2BS3/8M |
| 1/2   | 1/2        | ER1/2NP1/2M |
| 1/2   | 1/2        | ER1/2BS1/2M |



Espigão com rosca: 1/8" à 1" NPT ou BSP para manguerias: 1/4" à 1 1/2".  
Usinamos também espigão com haste conforme sua necessidade.

Medidas podendo variar de acordo com a peça.

Como solicitar

| Rosca   | Mangureira |
|---------|------------|
| 1/8" NP | 1/2 M      |

de Ø 1/8" até Ø 1" BSP ou NPT

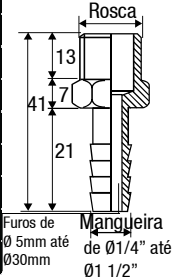

## Modelo BJA (Allen) - BJA (Fenda) - BUJÕES

| Bitolas | A  | B NPT ou BSP | C       | D   | E   | Código BJA (allen) | Código BJA (fenda) |
|---------|----|--------------|---------|-----|-----|--------------------|--------------------|
| 7/16"   | 12 | 1/8"         | 1/4"x8  | 3,0 | 2,0 | BJA-12             | BJF-12             |
| 9/16"   | 13 | 1/4"         | 1/4"x9  | 3,0 | 2,0 | BJA-13             | BJF-13             |
| 11/16"  | 14 | 3/8"         | 1/4"x10 | 3,0 | 2,0 | BJA-14             | BJF-14             |
| 7/8"    | 16 | 1/2"         | 1/4"x11 | 3,0 | 2,0 | BJA-16             | BJF-16             |

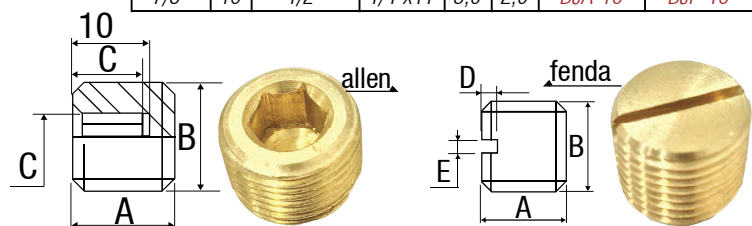

# REFRIGERAÇÃO - CONEXÕES RÁPIDAS

CONEXÕES de um Toque

|  |   |  |   |  |  |
|--|---|--|---|--|--|
| <b>PG</b><br><i>Redutor</i><br>                        | <b>PY</b><br><i>União Y</i><br>                          | <b>PUT</b><br><i>União tee</i><br>                  | <b>PT</b><br><i>Macho tee central</i><br>                | <b>PL</b><br><i>Macho Cotovelo</i><br>                       | <b>PC</b><br><i>Macho reta</i><br>                        |
| <b>NSE</b><br><i>Regulador de pressão cotovelo</i><br> | <b>PGJ</b><br><i>Plug-in redutor</i><br>                 | <b>PMM</b><br><i>Bulk head união cotovelo</i><br>   | <b>PWT</b><br><i>Macho Y</i><br>                         | <b>PCF</b><br><i>Fêmea reta</i><br>                          | <b>PST</b><br><i>Macho tee lateral</i><br>                |
| <b>NRL</b><br><i>Rotativo cotovelo</i><br>            | <b>NRC</b><br><i>Rotativo Reto</i><br>                  | <b>NSF</b><br><i>União regulador de fluxo</i><br>  | <b>PAT (D3)</b><br><i>Distribuidor saídas sexto</i><br> | <b>PAT (D2)</b><br><i>Distribuidor saídas quadruplo</i><br> | <b>PHT (D3)</b><br><i>Distribuidor saídas triplo</i><br> |
| <b>TC</b><br><i>Corta tubo</i><br>                   | <b>BC20</b><br><i>Válvula de esfera macho reta</i><br> | <b>BUG20</b><br><i>Válvula de esfera reta</i><br> | <b>PUL</b><br><i>União cotovelo</i><br>                | <b>PUC</b><br><i>União reta</i><br>                        | <b>PAF</b><br><i>Fêmea banjo duplo</i><br>              |

## Sistema de códigos de produtos

① Tipo do modelo

②

③

|    |   |    |
|----|---|----|
| PC | 8 | 02 |
| ①  | ② | ③  |

|                             |
|-----------------------------|
| Ø mangueira em mm           |
| 04 / 06 / 08 / 10 / 12 / 16 |

|           |     |     |     |     |    |
|-----------|-----|-----|-----|-----|----|
| Código    | 01  | 02  | 03  | 04  | 05 |
| Rosca NPT | 1/8 | 1/4 | 3/8 | 1/2 | M5 |

Como solicitar:

**PC 08 - 02**

Modelo PC Macho Reta para mangueira Poliuretano (PU) 8 mm de diâmetro externo e rosca de 1/4 NPT

Descrição código acima

## CARACTERÍSTICAS / VANTAGENS:

- Conexões rápidas "Um toque" em forma oval facilitam o engate e o desengate das tubulações
- Corpo metálico niquelado proporciona resistência contra desgaste e corrosão
- Roscas revestidas com teflon não necessitam de vedação adicional

## TABELAS TÉCNICAS DE ROSCAS EXTERNAS

| TABELAS TÉCNICAS DE ROSCAS EXTERNAS |      |      |              |      |           |           |      |      |         |      |      |         |      |
|-------------------------------------|------|------|--------------|------|-----------|-----------|------|------|---------|------|------|---------|------|
| BSP. (PARALELA)                     |      |      | NPT (CÔNICA) |      |           | WHITWORTH |      |      | UNF     |      |      | MÉTRICA |      |
| REF:                                | POL  | mm:  | REF:         | POL  | mm:       | REF:      | POL  | mm:  | REF:    | POL  | mm:  | REF:    | mm:  |
| B18                                 | 1/8" | 9,6  | N18          | 1/8" | 9,8-10,3  | W14       | 1/8" | 6,35 | 1/4"X28 | 1/8" | 6,35 | M5      | 4,9  |
| B14                                 | 1/4" | 13   | N14          | 1/4" | 13-13,8   | W38       | 1/4" | 9,5  | 3/8"X24 | 1/4" | 9,5  | M10     | 9,8  |
| B38                                 | 3/8" | 16,5 | N38          | 3/8" | 16,5-17,2 | W12       | 3/8" | 12,7 | 1/2"X20 | 3/8" | 12,7 | M12     | 11,8 |
| B12                                 | 1/2" | 20,7 | N12          | 1/2" | 20,6-21,3 | W58       | 1/2" | 15,8 | 5/8"X18 | 1/2" | 15,8 | M14     | 13,8 |
| B34                                 | 3/4" | 26,3 | N34          | 3/4" | 26-26,7   | W34       | 3/4" | 19   | 3/4"X16 | 3/4" | 19   | M16     | 15,8 |
| B1000                               | 1"   | 33   | N1000        | 1"   | 32,5-33,3 | W78       | 7/8" | 22,2 | 7/8"X14 | 7/8" | 22,2 | M20     | 19,8 |

# REFRIGERAÇÃO - REGULADOR, FILTRO E LUBRIFICADOR E TUBOS PU (Poliuretano)

Modelo TB - TUBO Poliuretano Liso/Esiral

## CARACTERÍSTICAS / VANTAGENS:

- Tubos de poliuretano feitos de polímero de alta qualidade com resistência química e elasticidade
- Poliuretano de propriedades excepcionais anti-abrasivas
- Durabilidade e flexibilidade
- Aplicações:
  - Ferramentas que utilizam Ar/Água
  - Sistemas Pneumáticos
  - Robôs Industriais
  - Sistema de Lubrificação



Liso – Cód TB

| Cód da Cor | Preto | Azul |
|------------|-------|------|
| Branco     | PR    | AZ   |
| Vermelho   | AM    | VD   |

Tubos Calibrados para conexão de engate rápido (instantânea)

| Ø código Liso-Cor | Externo | Interno | Parede | Pressão de trab. (bar) | Raio de Curva mm | Rolos M |
|-------------------|---------|---------|--------|------------------------|------------------|---------|
| TB-XX-M4          | 4,00    | 2,60    | 0,70   | 10                     | 15               | 100     |
| TB-XX-M6          | 6,00    | 4,00    | 1,00   | 10                     | 20               | 100     |
| TB-XX-M8          | 8,00    | 5,50    | 1,25   | 10                     | 35               | 100     |
| TB-XX-M10         | 10,00   | 7,00    | 1,50   | 10                     | 60               | 100     |
| TB-XX-M12         | 12,00   | 8,00    | 2,00   | 10                     | 65               | 50      |
| TB-XX-M16         | 16,00   | 11,00   | 2,50   | 10                     | 50               | 50      |

## Modelo AI (Inóx) AC (Aço) - ABRAÇADEIRA

| Ø Mínimo mm | Ø Máximo mm | Inox Código | SAE 1010/20 Código |
|-------------|-------------|-------------|--------------------|
| 9           | 13          | AI 913      | AC 913             |
| 12          | 16          | AI 1216     | AC 1216            |
| 13          | 19          | AI 1319     | AC 1319            |
| 14          | 22          | AI 1422     | AC 1422            |
| 19          | 27          | AI 1927     | AC 1927            |
| 22          | 32          | AI 2232     | AC 2232            |



Consulte-nos para tamanhos especiais  
Fabricadas em aço-carbono SAE 1010/20 ou aço-inox AISI 304, para uso em mangueiras de material macio, proporcionando grande capacidade de vedação.

Torque de aperto:  
- Aço carbono 35 kg.cm  
- Aço inox 40 kg.cm

## Modelo AV - ANÉIS de Vedação para Conectores

| Conector   | Unidades por embalagem | Material | Código |
|------------|------------------------|----------|--------|
| C011 /C012 | Borracha nitrilica     | 10       | AV 12  |
|            | Viton                  |          | AVV 12 |
| C013 /C014 | Borracha nitrilica     | 10       | AV 14  |
|            | Viton                  |          | AVV 14 |
| C015 /C016 | Borracha nitrilica     | 10       | AV 16  |
|            | Viton                  |          | AVV 16 |



## DESCONTINUADO

## Modelo CE - CONJUNTO Lubrifil (Regulador, Filtro e Lubrificador)

| Modelo                  | CE                             | CE       | CE                                   | CE       | CE       | CE       | CE       | CE       | CE       | CE       |
|-------------------------|--------------------------------|----------|--------------------------------------|----------|----------|----------|----------|----------|----------|----------|
|                         | 1010-M5                        | 2010-01  | 2010-02                              | 3010-02  | 3010-03  | 4010-03  | 4010-04  | 4010-06  | 5010-06  | 5010-10  |
| Médio                   | Ar Comprimido                  |          |                                      |          |          |          |          |          |          |          |
| Pressão (Mpa)           | 0 ~ 1.0                        |          |                                      |          |          |          |          |          |          |          |
| Max. Pressure (Mpa)     | 1,5                            |          |                                      |          |          |          |          |          |          |          |
| Temperatura (°C)        | 5 ~ 60                         |          |                                      |          |          |          |          |          |          |          |
| Filtro de precisão      | 25 micron (5micron é opcional) |          |                                      |          |          |          |          |          |          |          |
| Tamanho da rosca        | M5                             | 1/8"     | 1/4"                                 | 1/4"     | 3/8"     | 1/4"     | 1/2"     | 3/4"     | 3/4"     | 1"       |
| Medidor de rosca        | 1/16                           | 1/8"     |                                      |          | 1/4"     |          |          | 1/4"     |          |          |
| Medidor Modelo          | Y25                            | Y40      |                                      |          | Y50      |          |          | Y50      |          |          |
| Fluxo M(L/min)          | 900                            | 500      | 1700                                 |          |          | 3000     |          |          | 4000     |          |
| Suporte                 | Y10T                           | Y20T     | Y30T                                 |          |          | Y40T     | Y50T     | Y60T     |          |          |
| Material do corpo       | Ligados Alumínio               |          |                                      |          |          |          |          |          |          |          |
| Drenagem Tipo           | Drenagem manual                |          | Air Escorra Shut-Off/Drenagem Manual |          |          |          |          |          |          |          |
| Auto modelo de drenagem | /                              | CE       | CE                                   | CE       | CE       | CE       | CE       | CE       | CE       | CE       |
|                         |                                | 2010-01D | 2010-02D                             | 3010-02D | 3010-03D | 4010-03D | 4010-04D | 4010-06D | 5010-06D | 5010-10D |

Nota: thread diferente, cores de carroçarias estão disponíveis

